

BEFORE INSTALLATION

We recommend that this product is installed by a qualified professional contractor. Please flush the water system to ensure that no debris or any other impurities can enter the faucet. Turn off water supply before commencing work and read these instructions carefully.

TROUBLE SHOOTING

Problem	Cause	Action
Leaks underneath handle.	Cartridge is loose or damaged.	Make sure retaining nut is fully tightened. Adjust or replace cartridge if necessary.
Faucet has inconsistent water flow pattern or no flow at all.	Washer filter is dirty or mystified.	Unscrew supply lines from valves and rinse filter washers from debris.
Water will not shut off completely.	Dirty or worn out plastic washer in the cartridge.	Adjust or replace cartridge.

CLEANING AND CARE

Clean the faucet often with a soft cloth to keep it looking like new. For heavy cleaning you can use mild liquid detergents or non-abrasive liquid polisher. Rinse with water and dry with a soft cloth. Avoid abrasive cleaners, steel wool and harsh chemicals as these will dull the finish and void your warranty.

LIMITED LIFETIME WARRANTY

INOLAV provides its customers with an extensive warranty as a result of our excellent workmanship and high quality components used in our products.

Mechanical warranty: A limited lifetime warranty is provided on all mechanical parts to be free from manufacturing defects in materials and workmanship under normal use for as long as the original purchaser owns their home.

Finish warranty: A 5-year warranty is provided on all INOLAV faucet finishes to the original purchaser against manufacturing defects in materials and workmanship.

At its sole discretion, INOLAV will repair or replace any part or finish that proves to be defective in material and/or workmanship under normal installation, use and service.

This warranty is extended to the original consumer owner, but does not cover installation or any other labor charges. In no event shall INOLAV be liable for any incidental, consequential or special damages, installation cost, labor, travel time, freight costs incurred, lost profits, or contingent liabilities. INOLAV makes no representation that its products comply with any or all local building or plumbing codes. It is the consumer's responsibility to determine local code compliance.

For warranty issues call us at 1-855 472 4304 or send us an e-mail at warranty@inolav.com

inolav[®]
Inspired by beauty.

Model: **IF2007**

INSTALLATION MANUAL

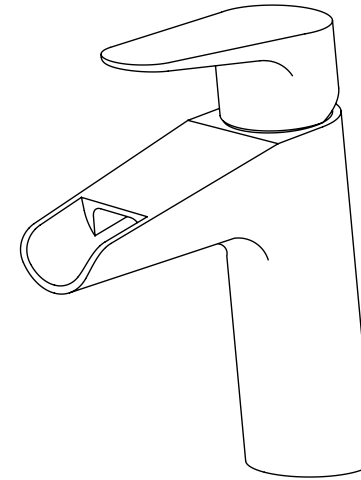

Compliance:
NSF/ANSI 61
ASME A112.18.1
CSA B125.1

PARTS INCLUDED

Before your installation please make sure you have received the parts indicated below.

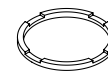

A Faucet o-ring x 1



B Rubber washer x 1

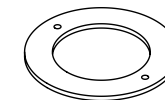

C Steel washer x 1



D Nut assembly x 1



E Filter washer x 2

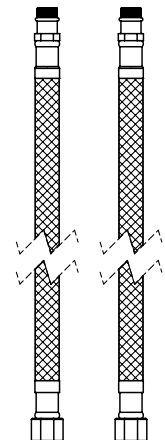

F Water line x 2

For questions call us at 1-855 472 4304 or visit our website at www.inolav.com

IF2007 Spec sheet

Single handle basin faucet.

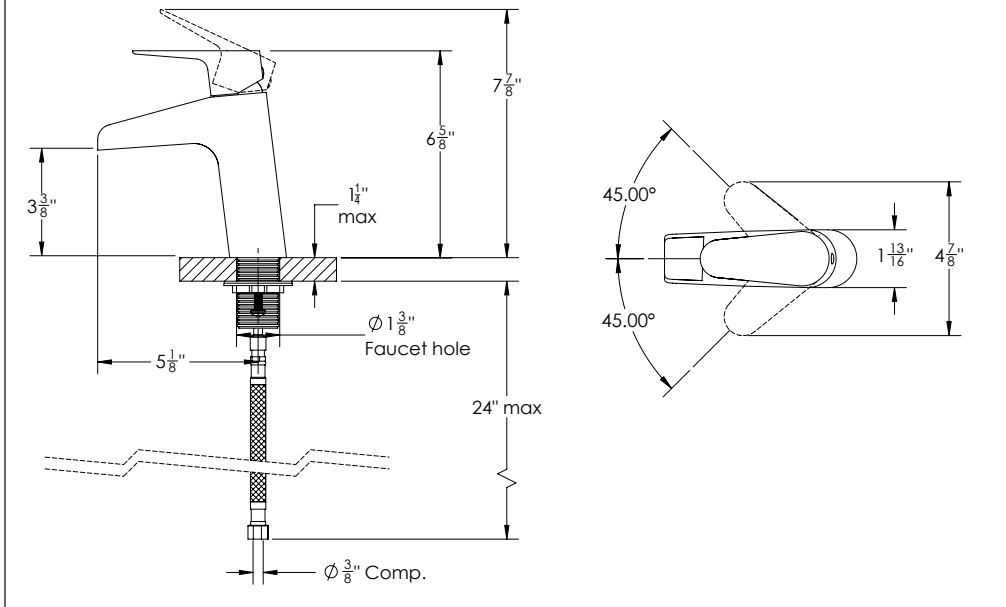

STEP 1

Screw waterlines into corresponding line connectors of faucet body. Make sure o-ring goes into the line connector. Do not over tighten.

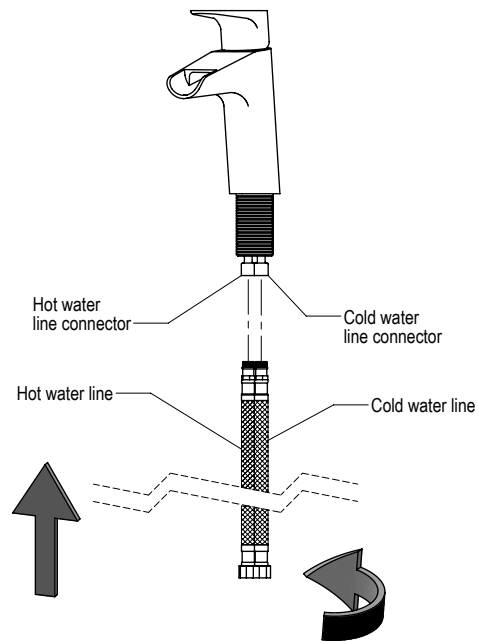

STEP 2

Secure faucet to counter top or basin using the mounting kit as described in the figure. 1-Insert faucet o-ring into groove of faucet body and insert threaded tube into faucet hole. 2-Align rubber and steel washer, and screw nut assembly by hand all the way up. 3-Using a phillips screw driver, tighten the nut assembly.

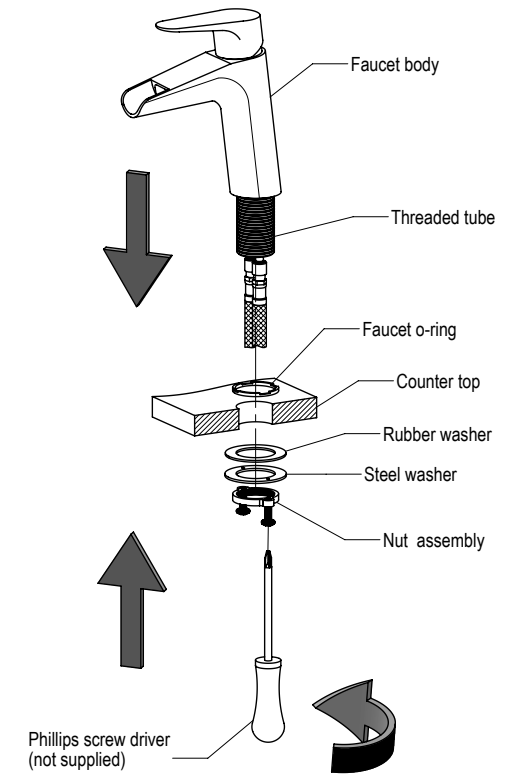

STEP 3

Screw bushings into water supply valves. Make sure to use filter washer as shown in the figure. Screw water lines into corresponding water supply lines (bushings) in the wall using a 5/8" wrench. Do not over tighten. Check for leakage.

